

# GRILL BOX

MODELO  
GB-CAC-120

//CAMPANA PARA EMPOTRAR//

## VISTAS GENERALES

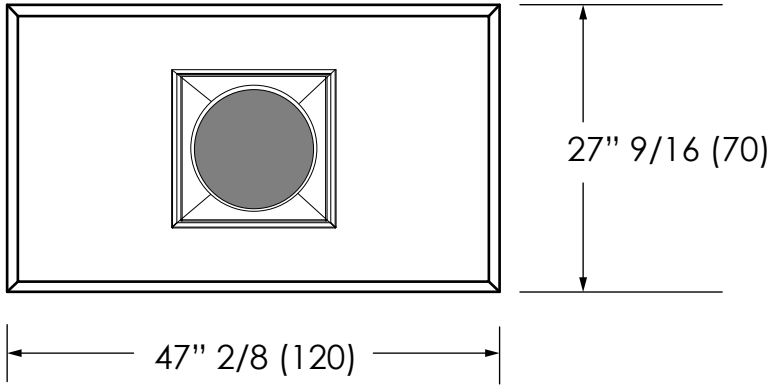

**VISTA PLANTA**

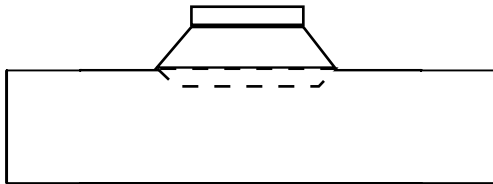

**VISTA FRONTAL**

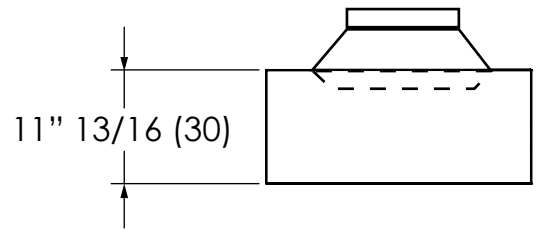

**VISTA LATERAL**

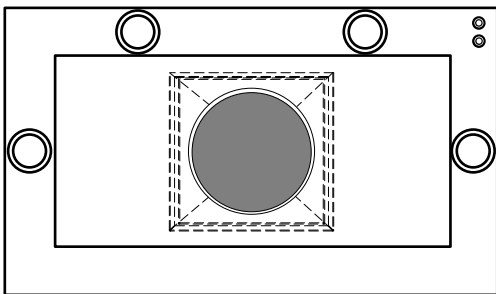

**VISTA INFERIOR**

ACOT. (") Y (CM)

FICHA TÉCNICA  
GB-CAC-120-ESP  
REV.00

MODELO  
GB-CAC-120

# GRILL BOX

//CAMPANA PARA EMPOTRAR//

## PREPARACIÓN PARA CAMPANA

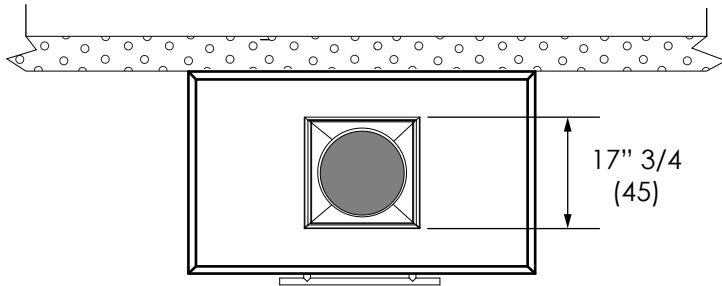

VISTA PLANTA

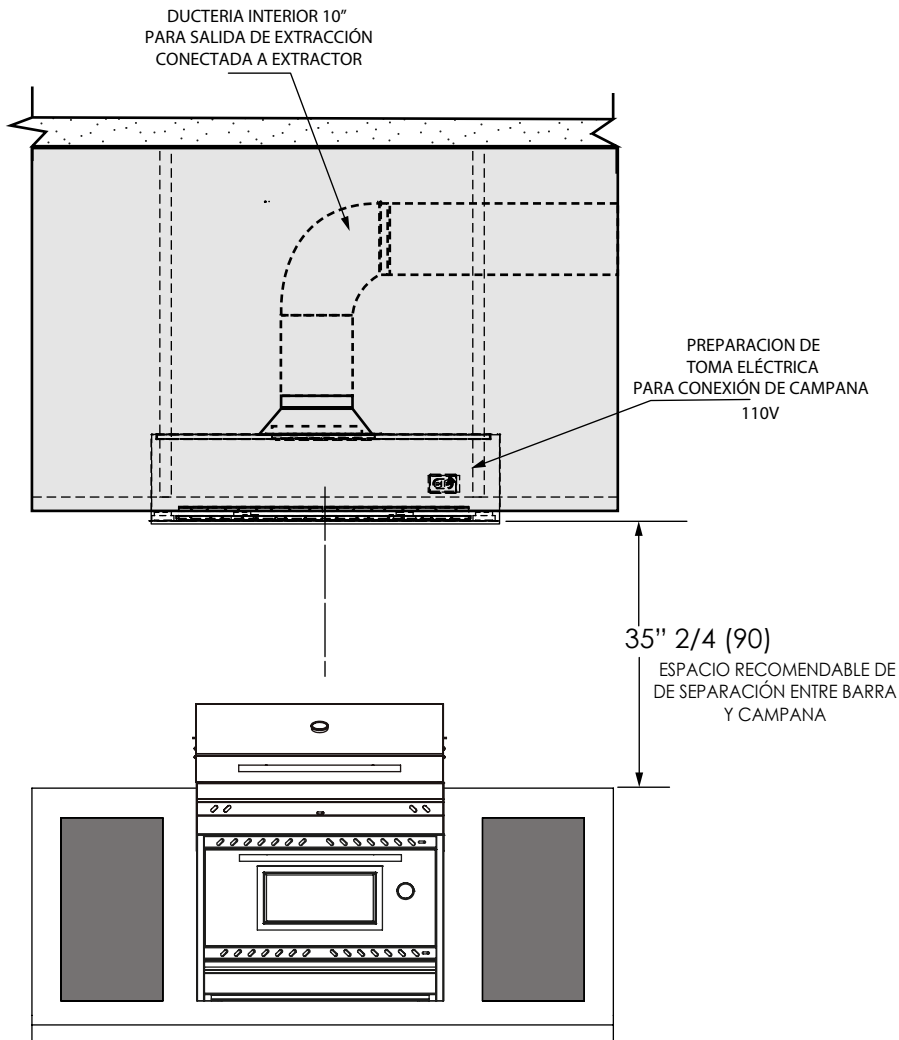

VISTA FRONTAL

NOTA: CAMPANA CENTRADA EN ASADOR.

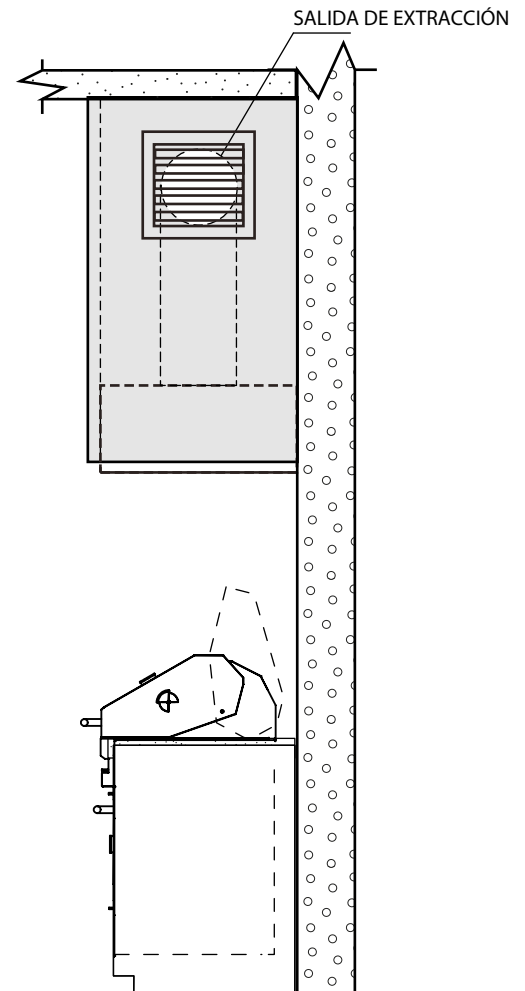

VISTA LATERAL

ACOT. (") Y (CM)

FICHA TÉCNICA  
GB-CAC-120-ESP  
REV.00